

STANLEY®

SK47 HYDRAULIC SINKER DRILL



USER MANUAL Safety, Operation and Maintenance



© 2014 STANLEY Black & Decker, Inc.
New Britain, CT 06053
U.S.A.
10323 8/2018 Ver. 11

TABLE OF CONTENTS

SAFETY SYMBOLS.....	4
SAFETY PRECAUTIONS	5
TOOL STICKERS & TAGS	6
HOSE TYPES	7
HOSE RECOMMENDATIONS.....	8
HTMA / EHTMA REQUIREMENTS	9
OPERATION	10
TOOL PROTECTION & CARE.....	12
CHARGING THE ACCUMULATOR.....	13
TROUBLESHOOTING	15
ACCESSORIES	16
SPECIFICATIONS	16
SK47 PARTS ILLUSTRATION	17
SK47 PARTS LIST	18

IMPORTANT

To fill out a product warranty validation form, and for information on your warranty, visit www.stanleyinfrastructure.com and select the Company tab > Warranty.

Note: The warranty validation record must be submitted to validate the warranty.

SERVICING: This manual contains safety, operation and routine maintenance instructions. STANLEY Infrastructure recommends that servicing of hydraulic tools, other than routine maintenance, must be performed by an authorized and certified dealer. Please read the following warning.

WARNING

SERIOUS INJURY OR DEATH COULD RESULT FROM THE IMPROPER REPAIR OR SERVICE OF THIS TOOL.

REPAIRS AND / OR SERVICE TO THIS TOOL MUST ONLY BE DONE BY AN AUTHORIZED AND CERTIFIED DEALER.

For the nearest certified dealer, call STANLEY Infrastructure at (503) 659-5660 and ask for a Customer Service Representative.

SAFETY SYMBOLS

Safety symbols and signal words, as shown below, are used to emphasize all operator, maintenance and repair actions which, if not strictly followed, could result in a life-threatening situation, bodily injury or damage to equipment.



This is the safety alert symbol. It is used to alert you to potential personal injury hazards. Obey all safety messages that follow this symbol to avoid possible injury or death.



This safety alert and signal word indicates an imminently hazardous situation which, if not avoided, will result in death or serious injury.



This safety alert and signal word indicates a potentially hazardous situation which, if not avoided, could result in death or serious injury.



This safety alert and signal word indicates a potentially hazardous situation which, if not avoided, could result in death or serious injury.



This signal word indicates a potentially hazardous situation which, if not avoided, may result in property damage.



This signal word indicates a situation which, if not avoided, will result in damage to the equipment.



This signal word indicates a situation which, if not avoided, may result in damage to the equipment.

Always observe safety symbols. They are included for your safety and for the protection of the tool.

LOCAL SAFETY REGULATIONS

Enter any local safety regulations here. Keep these instructions in an area accessible to the operator and maintenance personnel.

SAFETY PRECAUTIONS

Tool operators and maintenance personnel must comply with the safety precautions given in this manual and on the stickers and tags attached to the tool and hose.

These precautions are given for your safety. Review them carefully before operating the tool and before performing general maintenance or repairs.

The SK47 Hydraulic Sinker Drill will provide safe and dependable service if operated in accordance with the instructions given in this manual. Read and understand this manual and any stickers and tags attached to the tool and hoses before operation. Failure to do so could result in personal injury or equipment damage.



- Operator must start in a work area without bystanders. The operator must be familiar with all prohibited work areas such as excessive slopes and dangerous terrain conditions.
- Establish a training program for all operators to ensure safe operation.
- Do not operate the tool unless thoroughly trained or under the supervision of an instructor.
- Always wear safety equipment such as goggles, ear, head and breathing protection, and safety shoes at all times when operating the tool.
- Do not inspect or clean the tool while the hydraulic power source is connected. Accidental engagement of the tool can cause serious injury.
- Supply hoses must have a minimum working pressure rating of 2500 psi/175 bar.
- The hydraulic circuit control valve must be in the **OFF** position when coupling or uncoupling the tool. Wipe all couplers clean before connecting. Use only lint-free cloths. Failure to do so may result in damage to the quick couplers and cause overheating of the hydraulic system.
- Do not operate the tool at oil temperatures above 140 °F/60 °C. Operation at higher oil temperatures can cause operator discomfort and may damage the tool.
- Do not operate a damaged, improperly adjusted or incompletely assembled tool.
- Do not weld, cut with an acetylene torch or hard-face the tool bit.
- To avoid personal injury or equipment damage, all tool repair, maintenance and service must only be performed by authorized and properly trained personnel.
- Do not exceed the rated limits of the tool or use the tool for applications beyond its design capacity.
- Always keep critical tool markings, such as labels and warning stickers, legible.
- Always replace parts with replacement parts recommended by STANLEY.
- Check fastener tightness often and before each use daily.
- Never operate the tool if you cannot be sure that underground utilities are not present.
- Do not wear loose fitting clothing when operating the tool.
- **WARNING:** Some dust created by power sanding, sawing, grinding, drilling, and other construction activities contains chemicals known to the State of California to cause cancer, birth defects or other reproductive harm. Some examples of these chemicals are:
 - Lead from lead-based paints,
 - crystalline silica from bricks and cement and other masonry products, and
 - arsenic and chromium from chemically-treated lumber.

Your risk from these exposures varies, depending on how often you do this type of work. To reduce your exposure to these chemicals: work in a well ventilated area, and work with approved safety equipment, such as those dust masks that are specially designed to filter out microscopic particles.

Protect yourself and those around you. Research and understand the materials you are cutting. Follow correct safety procedures and comply with all applicable national, state or provisional health and safety regulations relating to them, including, if appropriate arranging for the safe disposal of the materials by a qualified person.

TOOL STICKERS & TAGS



Stanley Hydraulic Tools
Division of The Stanley Works
3810 SE Naef Road
Milwaukie, Oregon 97267 USA

SK47 SINKER DRILL

FLOW: 7.9 GPM/26.34 LPM
PRESS.: 1500-2000 PSI
ACCUMULATOR CHARGE:
600 PSI NITROGEN

08103
SK47 Name Tag

NOTE:

THE INFORMATION LISTED ON THE STICKERS SHOWN, MUST BE LEGIBLE AT ALL TIMES.

REPLACE DECALS IF THEY BECOME WORN OR DAMAGED. REPLACEMENTS ARE AVAILABLE FROM YOUR LOCAL STANLEY DISTRIBUTOR.

The safety tag (P/N 15875) at right is attached to the tool when shipped from the factory. Read and understand the safety instructions listed on this tag before removal. We suggest you retain this tag and attach it to the tool when not in use.

DANGER

1. FAILURE TO USE HYDRAULIC HOSE LABELED AND CERTIFIED AS NON-CONDUCTIVE WHEN USING HYDRAULIC TOOLS ON OR NEAR ELECTRICAL LINES MAY RESULT IN DEATH OR SERIOUS INJURY.
BEFORE USING HOSE LABELED AND CERTIFIED AS NON-CONDUCTIVE ON OR NEAR ELECTRICAL LINES BE SURE THE HOSE IS MAINTAINED AS NON-CONDUCTIVE. THE HOSE SHOULD BE REGULARLY TESTED FOR ELECTRIC CURRENT LEAKAGE IN ACCORDANCE WITH YOUR SAFETY DEPARTMENT INSTRUCTIONS.
2. A HYDRAULIC LEAK OR BURST MAY CAUSE OIL INJECTION INTO THE BODY OR CAUSE OTHER SEVERE PERSONAL INJURY.
 - A. **DO NOT** EXCEED SPECIFIED FLOW AND PRESSURE FOR THIS TOOL. EXCESS FLOW OR PRESSURE MAY CAUSE A LEAK OR BURST.
 - B. **DO NOT** EXCEED RATED WORKING PRESSURE OF HYDRAULIC HOSE USED WITH THIS TOOL. EXCESS PRESSURE MAY CAUSE A LEAK OR BURST.
 - C. CHECK TOOL HOSE COUPLERS AND CONNECTORS DAILY FOR LEAKS. **DO NOT** FEEL FOR LEAKS WITH YOUR HANDS. CONTACT WITH A LEAK MAY RESULT IN SEVERE PERSONAL INJURY.

IMPORTANT

READ OPERATION MANUAL AND SAFETY INSTRUCTIONS FOR THIS TOOL BEFORE USING IT.

USE ONLY PARTS AND REPAIR PROCEDURES APPROVED BY STANLEY AND DESCRIBED IN THE OPERATION MANUAL.

TAG TO BE REMOVED ONLY BY TOOL OPERATOR.

SEE OTHER SIDE

DANGER

- D. **DO NOT** LIFT OR CARRY TOOL BY THE HOSES. **DO NOT** ABUSE HOSE. **DO NOT** USE KINKED, TORN OR DAMAGED HOSE.
3. **MAKE SURE** HYDRAULIC HOSES ARE PROPERLY CONNECTED TO THE TOOL BEFORE PRESSURING SYSTEM. SYSTEM PRESSURE HOSE MUST ALWAYS BE CONNECTED TO TOOL "IN" PORT. SYSTEM RETURN HOSE MUST ALWAYS BE CONNECTED TO TOOL "OUT" PORT. REVERSING CONNECTIONS MAY CAUSE REVERSE TOOL OPERATION WHICH CAN RESULT IN SEVERE PERSONAL INJURY.
4. **DO NOT** CONNECT OPEN-CENTER TOOLS TO CLOSED-CENTER HYDRAULIC SYSTEMS. THIS MAY RESULT IN LOSS OF OTHER HYDRAULIC FUNCTIONS POWERED BY THE SAME SYSTEM AND/OR SEVERE PERSONAL INJURY.
5. **BYSTANDERS** MAY BE INJURED IN YOUR WORK AREA. **KEEP BYSTANDERS CLEAR** OF YOUR WORK AREA.
6. **WEAR HEARING, EYE, FOOT, HAND AND HEAD PROTECTION.**
7. **TO AVOID PERSONAL INJURY OR EQUIPMENT DAMAGE, ALL TOOL REPAIR MAINTENANCE AND SERVICE MUST ONLY BE PERFORMED BY AUTHORIZED AND PROPERLY TRAINED PERSONNEL.**

IMPORTANT

READ OPERATION MANUAL AND SAFETY INSTRUCTIONS FOR THIS TOOL BEFORE USING IT.

USE ONLY PARTS AND REPAIR PROCEDURES APPROVED BY STANLEY AND DESCRIBED IN THE OPERATION MANUAL.

TAG TO BE REMOVED ONLY BY TOOL OPERATOR.

SEE OTHER SIDE

SAFETY TAG P/N 15875 (Shown smaller than actual size)

HOSE TYPES

The rated working pressure of the hydraulic hose must be equal to or higher than the relief valve setting on the hydraulic system. There are three types of hydraulic hose that meet this requirement and are authorized for use with STANLEY hydraulic tools. They are:

Certified non-conductive — constructed of thermoplastic or synthetic rubber inner tube, synthetic fiber braid reinforcement, and weather resistant thermoplastic or synthetic rubber cover. *Hose labeled **certified non-conductive** is the only hose authorized for use near electrical conductors.*

Wire-braided (conductive) — constructed of synthetic rubber inner tube, single or double wire braid reinforcement, and weather resistant synthetic rubber cover. *This hose is **conductive** and must never be used near electrical conductors.*

Fabric-braided (not certified or labeled non-conductive) — constructed of thermoplastic or synthetic rubber inner tube, synthetic fiber braid reinforcement, and weather resistant thermoplastic or synthetic rubber cover. *This hose is **not certified non-conductive** and must never be used near electrical conductors.*

HOSE SAFETY TAGS

To help ensure your safety, the following DANGER tags are attached to all hose purchased from STANLEY. DO NOT REMOVE THESE TAGS.

If the information on a tag is illegible because of wear or damage, replace the tag immediately. A new tag may be obtained from your STANLEY Distributor.

THE TAG SHOWN BELOW IS ATTACHED TO “CERTIFIED NON-CONDUCTIVE” HOSE

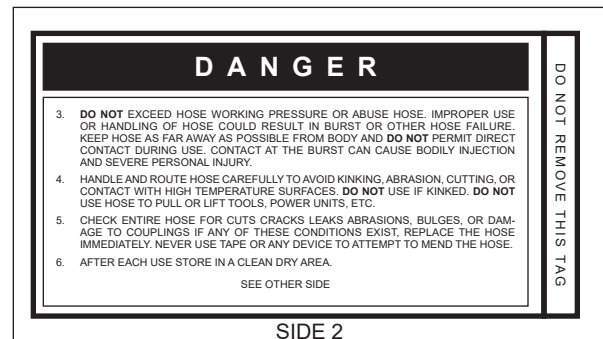
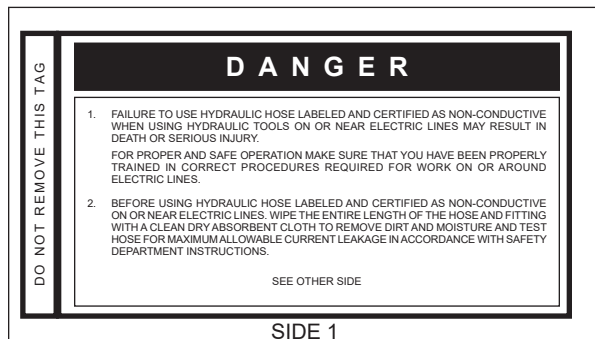

(Shown smaller than actual size)

THE TAG SHOWN BELOW IS ATTACHED TO “CONDUCTIVE” HOSE.

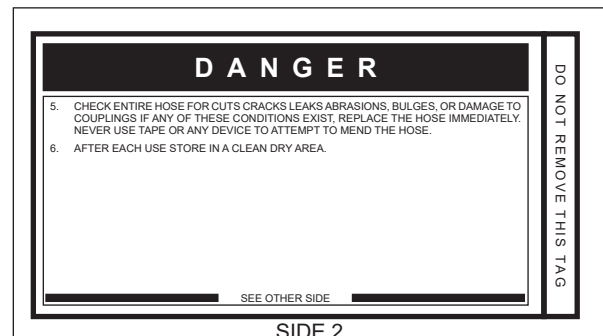
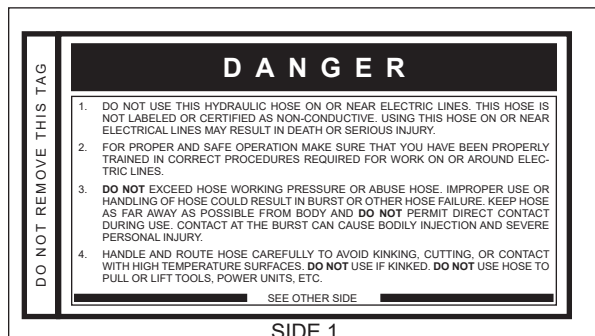

(Shown smaller than actual size)

HOSE RECOMMENDATIONS

Tool to Hydraulic Circuit Hose Recommendations

The chart to the right shows recommended minimum hose diameters for various hose lengths based on gallons per minute (GPM)/liters per minute (LPM). These recommendations are intended to keep return line pressure (back pressure) to a minimum acceptable level to ensure maximum tool performance.

This chart is intended to be used for hydraulic tool applications only based on STANLEY tool operating requirements and should not be used for any other applications.

All hydraulic hose must have at least a rated minimum working pressure equal to the maximum hydraulic system relief valve setting.

All hydraulic hose must meet or exceed specifications as set forth by SAE J517.

Oil Flow		Hose Lengths		Inside Diameter		USE (Press/Return)	Min. Working Pressure	
GPM	LPM	FEET	METERS	INCH	MM		PSI	BAR
Certified Non-Conductive Hose - Fiber Braid - for Utility Bucket Trucks								
4-9	15-34	up to 10	up to 3	3/8	10	Both	2250	155
Conductive Hose - Wire Braid or Fiber Braid - DO NOT USE NEAR ELECTRICAL CONDUCTORS								
4-6	15-23	up to 25	up to 7.5	3/8	10	Both	2500	175
4-6	15-23	26-100	7.5-30	1/2	13	Both	2500	175
5-10.5	19-40	up to 50	up to 15	1/2	13	Both	2500	175
5-10.5	19-40	51-100	15-30	5/8	16	Both	2500	175
5-10.5	19-40	100-300	30-90	5/8	16	Pressure	2500	175
10-13	38-49	up to 50	up to 15	3/4	19	Return	2500	175
10-13	38-49	51-100	15-30	5/8	16	Both	2500	175
10-13	38-49	100-200	30-60	3/4	19	Return	2500	175
13-16	49-60	up to 25	up to 8	1	25.4	Pressure	2500	175
13-16	49-60	26-100	8-30	5/8	16	Pressure	2500	175
				3/4	19	Return	2500	175
				3/4	19	Pressure	2500	175
				1	25.4	Return	2500	175

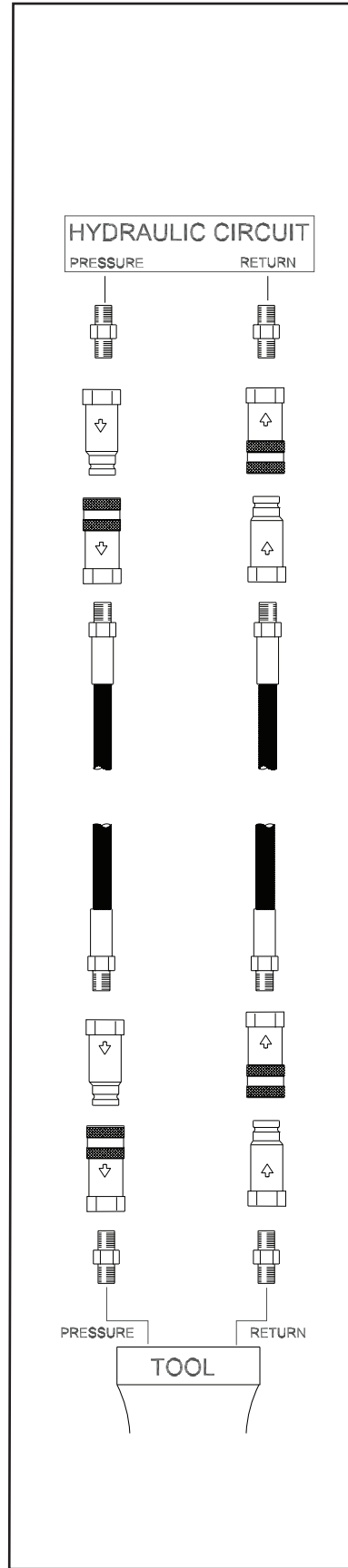

Figure 1. Typical Hose Connections





HTMA / EHTMA REQUIREMENTS

HTMA / EHTMA REQUIREMENTS

TOOL TYPE

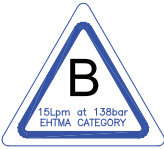
HTMA HYDRAULIC SYSTEM REQUIREMENTS	TYPE I	TYPE II	TYPE RR	TYPE III
Flow range	4-6 GPM (15-23 LPM)	7-9 GPM (26-34 LPM)	9-10.5 GPM (34-40 LPM)	11-13 GPM (42-49 LPM)
Nominal operating pressure (At the power supply outlet)	1500 psi (103 bar)	1500 psi (103 bar)	1500 psi (103 bar)	1500 psi (103 bar)
System relief valve setting (At the power supply outlet)	2100-2250 psi (145-155 bar)	2100-2250 psi (145-155 bar)	2200-2300 psi (152-159 bar)	2100-2250 psi (145-155 bar)
Maximum back pressure (At tool end of the return hose)	250 psi (17 bar)	250 psi (17 bar)	250 psi (17 bar)	250 psi (17 bar)
Measured at a max fluid viscosity of: (At minimum operating temperature)	400 ssu* (82 centistokes)	400 ssu* (82 centistokes)	400 ssu* (82 centistokes)	400 ssu* (82 centistokes)
Temperature: Sufficient heat rejection capacity to limit maximum fluid temperature to: (At maximum expected ambient temperature)	140° F (60° C)	140° F (60° C)	140° F (60° C)	140° F (60° C)
Minimum cooling capacity at a temperature difference of between ambient and fluid temps	3 hp (2.24 kW) 40° F (22° C)	5 hp (3.73 kW) 40° F (22° C)	6 hp (5.22 kW) 40° F (22° C)	7 hp (4.47 kW) 40° F (22° C)
Note: Do not operate the tool at oil temperatures above 140° F (60° C). Operation at higher temperatures can cause operator discomfort at the tool.				
Filter minimum full-flow filtration Sized for flow of at least: (For cold temp startup and maximum dirt-holding capacity)	25 microns 30 GPM (114 LPM)	25 microns 30 GPM (114 LPM)	25 microns 30 GPM (114 LPM)	25 microns 30 GPM (114 LPM)
Hydraulic fluid, petroleum based (premium grade, anti- wear, non-conductive) Viscosity (at minimum and maximum operating temps)	100-400 ssu (20-82 centistokes)	100-400 ssu (20-82 centistokes)	100-400 ssu (20-82 centistokes)	100-400 ssu (20-82 centistokes)
Note: When choosing hydraulic fluid, the expected oil temperature extremes that will be experienced in service determine the most suitable temperature viscosity characteristics. Hydraulic fluids with a viscosity index over 140 will meet the requirements over a wide range of operating temperatures.				
*SSU = Saybolt Seconds Universal				

CLASSIFICATION

EHTMA HYDRAULIC SYSTEM REQUIREMENTS					
Flow range	3.5-4.3 GPM (13.5-16.5 LPM)	4.7-5.8 GPM (18-22 LPM)	7.1-8.7 GPM (27-33 LPM)	9.5-11.6 GPM (36-44 LPM)	11.8-14.5 GPM (45-55 LPM)
Nominal operating pressure (At the power supply outlet)	1870 psi (129 bar)	1500 psi (103 bar)	1500 psi (103 bar)	1500 psi (103 bar)	1500 psi (103 bar)
System relief valve setting (At the power supply outlet)	2495 psi (172 bar)	2000 psi (138 bar)	2000 psi (138 bar)	2000 psi (138 bar)	2000 psi (138 bar)

Note: These are general hydraulic system requirements. See tool specification page for tool specific requirements.

OPERATION

The recommended hose size is .500 inch/12 mm ID up to 50 ft/15 m long and .625 inch/16 mm ID minimum up to 100 ft/30 m.

PRE-OPERATION PROCEDURES

CHECK POWER SOURCE

1. Using a calibrated flow meter and pressure gauge, check that the hydraulic power source develops a flow of 7–9 GPM/26–34 LPM at 1500–2000 psi/105–140 bar.
2. Make certain the hydraulic power source is equipped with a relief valve set to open at 2100–2250 psi/145–155 bar maximum.

INSTALL DRILL STEEL & ROCK BIT

Use standard 4-1/4 inch shank × 7/8 inch hex drill steels.

Drill steels are available in a variety of lengths. Start with a short length so that the tool may be operated at a normal standing position. The tool handles should never exceed chest height during operation.

1. Thread a rock bit onto the drill steel.
2. Rotate the latch out and up.
3. Slide the drill steel into the tool.
4. Rotate the latch down being careful not to pinch your fingers. When correctly installed, the collar on the drill steel should be above the bottom of the latch.

CONNECT HOSES

1. Wipe all hose couplers with a clean, lint-free cloth before making connections.
2. Connect the hoses from the hydraulic power source to the tool fittings or quick disconnects. It is a good practice to connect return hoses first and disconnect them last to minimize or avoid trapped pressure within the tool.
3. Observe flow indicators stamped on hose couplers to ensure that fluid flow is in the proper direction. The female coupler on the tool hose is the inlet coupler.
4. Move the hydraulic circuit control valve to the ON position to operate the tool.

Note: If uncoupled hoses are left in the sun, pressure increase within the hoses may make them difficult to connect. Connect the free ends of the hoses together.

5. Connect the hose from the air supply to the hose on the tool.

NOTICE

The air supply must be minimum 30 cfm at 120 psi. Supplying less than these specifications may result in inadequate extraction of rock cuttings; cause cuttings to migrate up the drill steel and into the tool and result in tool damage; diminish drilling time; and cause premature wear of the drill bit.

OPERATION PROCEDURES

1. Observe all safety precautions.
2. Install the appropriate tool bit for the job.
3. Start the hydraulic supply and turn the circuit control valve to the ON position.
4. Open the air valve on the tool just enough to permit a small amount of air flow from the tool bit.

Note: Air flow must be continuous during drilling to avoid clogging of the air passages and/or back-flushing of waste products into the drill.

5. Place the bit firmly on the surface to be drilled. Do not operate the sinker drill without the drill steel in contact with the work surface. Adequate down pressure is very important.
6. Several methods can be used to reduce the tendency for the drill to “walk” on the surface to be drilled before the hole is initiated.

If the trigger is partially depressed, the piston will cycle at low speed, without tool bit rotation, allowing a start hole to be made. This will keep the drill in place when full power is applied.

Rotating the motor control lever straight up will shut off all rotation allowing the operator to establish a starting hole prior to full application.

7. The rotation control lever controls rotation speed from 0 to approximately 300 rpm. Normal drilling is best accomplished with the lever halfway between fully on and straight up off position.

Note: Normal drill rotation is counterclockwise when viewed from the top of the tool. The clockwise rotation position of the motor control lever has been blocked with a roll pin stop to avoid unscrewing a drill bit at the bottom of the drilled hole.

8. Ensure the rock bit is rotating at a moderate speed (not too fast, not too slow). When starting the hole, it is best to start at a slow impact and rotation speed until the rock bit has carved out a depression in the material being drilled. If the rock bit is not rotating

OPERATION

open the hydraulic valve lever further. If the rock bit still does not rotate adjust the motor control knob until rotation is achieved.

9. After the rock bit has carved out a depression in the material being drilled, open the hydraulic valve lever fully. Readjust the motor control knob to obtain a good drilling speed. Adjust the air valve to ensure the cuttings are being extracted from the drill hole.
10. Keep the drill steel centered in the hole.
11. Insufficient air flow can cause the drill steel to bind in the hole.
12. Apply adequate feed pressure to the sinker drill to maintain optimum drilling performance.
13. When drilling deep holes, it is advantageous to stop drilling every 1 to 2 minutes. This allows the receiver and hoses to charge and provide a short burst of air when the tool is again turned on to clear excess cutting from the hole.
14. When the bottom of the tool comes within 6 inches of the drill hole, it is time to either add another section of drill steel or replace the existing drill steel with a longer section. Close the hydraulic valve lever but leave the air valve **ON** and then lift the tool with drill steel and rock bit out of the hole. Leaving the air valve **ON** helps prevent cuttings from falling around the bit while the bit is lifted from the hole.
15. When the tool, drill steel and bit have been removed from the drill hole, turn the valve lever **OFF** and turn the hydraulic supply circuit control valve **OFF** before changing the drill steel or rock bit.

whichever is higher.

- Air hoses must have an oil-resistant inner surface and an abrasion-resistant exterior surface. When severe operating conditions make the possibility of cutting or damaging the hose likely, the hose shall be of extra-ply armored, or other protective construction.
- Pressure regulators shall be used to limit maximum air pressure at the tool to 100 psi/7 bar.
- An accessible means for shutting off the air supply to the sinker drill should be provided.
- Automatic filtering systems are recommended.

COLD WEATHER OPERATION

If the breaker is to be used during cold weather, preheat the hydraulic fluid at low engine speed. When using the normally recommended fluid, fluid temperature should be at or above 50 °F/10 °C (400 ssu/82 centistokes) before use.

Damage to the hydraulic system or breaker can result from use with fluid that is too viscous or thick.

FLUSHING REQUIREMENTS

- The SK47 is designed for air flushing only.
- The minimum of CFM/7 liters per second at 75 psi/5 bar of compressed air should be used for flushing the chips out of the drilled hole.
- The minimum recommended hose size is 3/8-inch/10 mm ID and must have a minimum working pressure rating of 150 psi/10 bar or 150 percent of the maximum pressure produced by the system,

TOOL PROTECTION & CARE

NOTICE

In addition to the safety precautions found in this manual, observe the following for equipment protection and care.

- Make sure all couplers are wiped clean before connection.
- The hydraulic circuit control valve must be in the **OFF** position when coupling or uncoupling hydraulic tools. Failure to do so may result in damage to the quick couples and cause overheating of the hydraulic system.
- Always store the tool in a clean dry space, safe from damage or pilferage.
- Make sure the circuit **PRESSURE** hose (with male quick disconnect) is connected to the **IN** port. The circuit **RETURN** hose (with female quick disconnect) is connected to the opposite port. Do not reverse circuit flow. This can cause damage to internal seals.
- Always replace hoses, couplings and other parts with replacement parts recommended by STANLEY. Supply hoses must have a minimum working pressure rating of 2500 psi/172 bar.
- Do not exceed the rated flow and pressure. See Specifications in this manual for correct flow rate and pressure rating. Rapid failure of the internal seals may result.
- Always keep critical tool markings, such as warning stickers and tags, legible.
- Keep tool bit sharp for maximum drilling performance. Make sure that tool bits are not chipped or rounded on the striking end.
- Never operate a hammer drill without a tool bit or without holding it against the work surface.
- Tool repair should be performed by experienced personnel only.
- Make certain that the recommended relief valves are installed in the pressure side of the system.
- Do not use the tool for applications for which it was not intended.

CHARGING THE ACCUMULATOR

ACCUMULATOR TESTING PROCEDURE

To check or charge the accumulator the following equipment is required:

31254 Charge Kit: which includes the following (see Figure 2).

- Accumulator Tester (Part Number 02835).
 - Charging Assembly (P/N 15304) Includes a liquid filled gauge w/snub valve, hose and charge fitting.
 - NITROGEN bottle with a 800 psi/56 bar minimum charge (NOT included in 31254 Charge Kit.)
1. Remove the valve cap assembly from the sinker drill (see Figure 2 for location).
 2. Remove the protective cap and loosen the 5/8-inch hex locking nut on the tool charging valve 1-1/2 turns.
 3. Holding the chuck end of Accumulator Tester (P/N 02835) turn the gauge fully counterclockwise to ensure that the stem inside the chuck is completely retracted.
 4. Thread the tester onto the accumulator charging valve. Do not advance the gauge-end into the chuck-end. Turn as a unit. Seat the chuck on the accumulator charging valve and hand tighten only.
 5. Advance the valve stem of the tester by turning the gauge-end clockwise until a pressure is read on the gauge (charge pressure should be 600–700 psi/42–48 bar).
 6. If pressure is OK, unscrew the gauge-end from the chuck to retract the stem, then unscrew the entire tester assembly from the accumulator charging valve. If pressure is low, charge the accumulator as described in the following paragraph.
 7. Tighten the 5/8-inch hex locking nut on the tool charging valve. Be careful not to overtighten. Install the protective cap and valve cap assembly.

ACCUMULATOR CHARGING

1. Perform Steps 1 through 4 of the accumulator testing procedure above.
2. Connect the chuck of the charging assembly to the charging valve on the accumulator tester or, if preferred, remove the tester from the charging valve and connect the charging assembly chuck directly to the charging valve.
3. Adjust the regulator to the charging pressure of 600 psi/42 bar.

Note: It may be necessary to set the gauge at 650-

700 psi/45-48 bar to overcome any pressure drop through the charging system.

4. Open the valve on the charging assembly hose.
5. When the accumulator is fully charged close the valve on the charging assembly hose and remove the charging assembly chuck from the accumulator tester or tool charging valve.
6. If the accumulator tester has been used, be sure to turn the gauge-end fully counterclockwise before removing the tester from the charging valve of the tool.
7. Tighten the 5/8-inch hex locking nut on the tool charging valve and replace the protective cap.
8. Replace the valve cap assembly.

CHARGING THE ACCUMULATOR

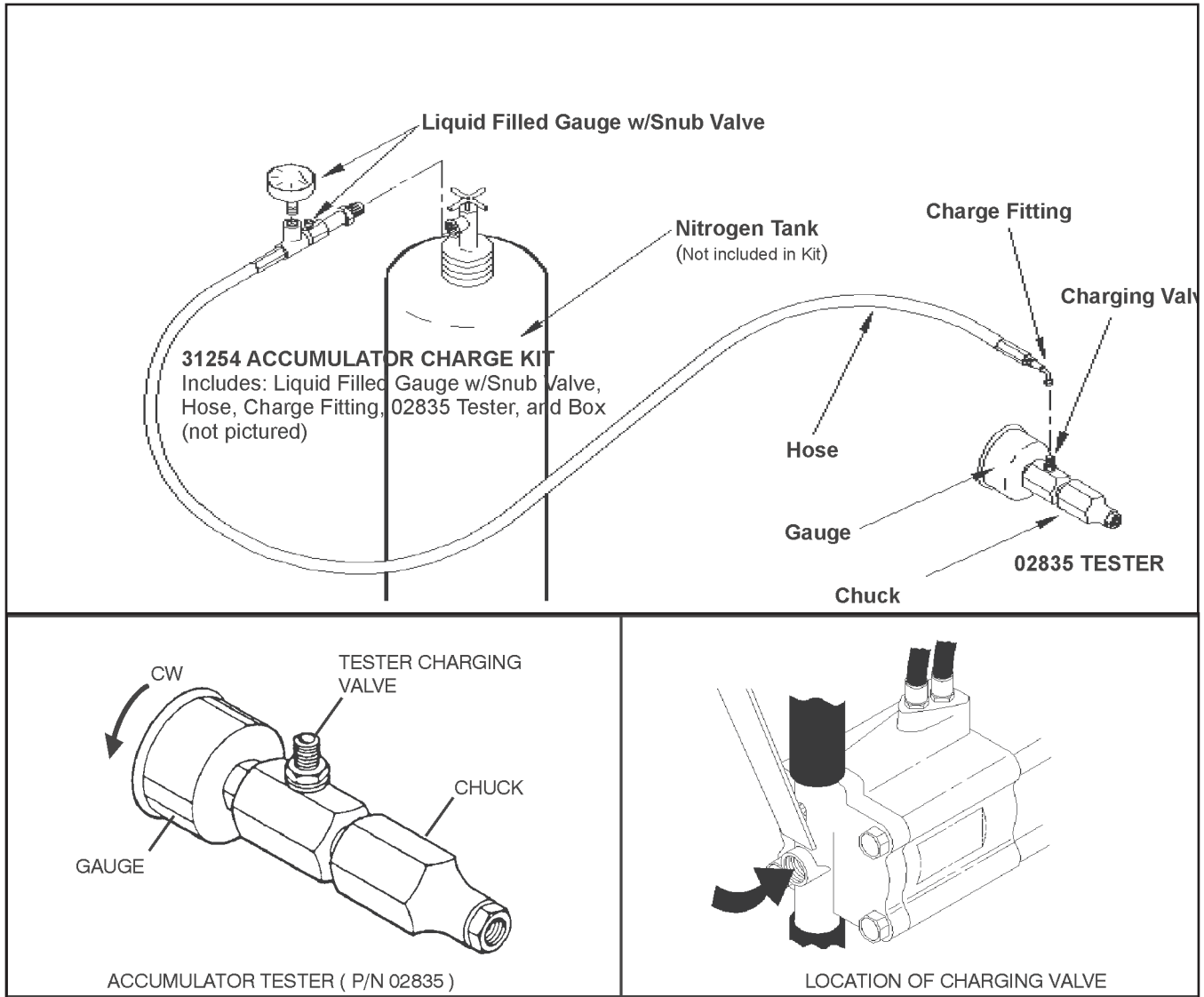

Figure 2. Charging the Accumulator

TROUBLESHOOTING

PROBLEM	CAUSE	SOLUTION
Tool does not run.	Power unit not functioning.	Check power unit for proper flow and pressure (7–9 GPM/26–34 LPM, 1500–2000 psi/105–140 bar).
	Couplers or hoses blocked.	Remove restriction.
	Pressure and return line hoses reversed at ports.	Be sure hoses are connected to their proper ports.
	Mechanical failure of piston or automatic valve.	Disassemble breaker and inspect for damaged parts.
Tool does not drill effectively.	Power unit not functioning.	Check power unit for proper flow and pressure (7–9 GPM/26–34 LPM, 1500–2000 psi/105–140 bar).
	Couplers or hoses blocked.	Remove restriction.
	Low accumulator charge (pressure hose will pulse more than normal).	Recharge accumulator. Replace diaphragm if charge loss continues.
	Fluid too hot (above 140 °F/60 °C).	Provide cooler to maintain proper fluid temperature (130 °F/55 °C).
	Insufficient air or water.	15–25 cfm/7–12 liters per second minimum required.
Tool operates slow.	Low GPM supply from power unit.	Check power unit for proper flow (7–9 GPM/26–34 LPM).
	High back-pressure.	Check hydraulic system for excessive back-pressure (over 250 psi/17 bar).
	Couplers or hoses blocked.	Remove restriction.
	Orifice plug blocked.	Remove restriction.
	Fluid too hot (above 140 °F/60 °C) or too cold (below 60 °F/16 °C).	Check power unit for proper fluid temperature. Bypass cooler to warm the fluid or provide cooler to maintain proper temperature.
	Relief valve set too low.	Adjust relief valve to 2100–2250 psi/145–155 bar.
Tool gets hot.	Hot fluid going through tool.	Check power unit. Be sure flow rate is not too high causing part of the fluid to go through the relief valve. Provide cooler to maintain proper fluid temperature (140°F/60°C max). Check the relief valve setting.
Fluid leakage on drill steel.	Lower piston or drive hex seal failure.	Replace seals.
Fluid leakage through charge valve cap.	Upper piston seal failure or accumulator O-ring failure or accumulator charge loss or failure.	Replace seals, recharge or replace accumulator diaphragm.
Fluid leakage around trigger.	Valve spool seal failure.	Replace seals.
Low rotation torque.	Motor not completely broken in.	Continue operation to break in motor.
	Excessive oil temperature causes operating pressure loss.	Provide cooler to maintain oil temperature (under 140 °F).
	Damage to motor clearances.	Repair as required.
	Insufficient air or water.	15–25 cfm/7–12 liters per second minimum required.
	Mechanical binding during drilling.	Take care to guide drill straight.

SPECIFICATIONS

Shank Size	4-1/4 in. × 7/8 in. Hex/108 mm × 22 mm
Pressure Range.....	1500-2000 psi/105-140 bar
Flow Range	7-9 GPM/26-34 LPM
Optimum Flow	9 GPM/34 LPM
Maximum Back Pressure.....	250 Psi/17 bar
Connect Size & Type	3/8 in. Male Pipe Hose End
Weight	52 lbs/24 kg
Length.....	23 in./58 cm
Width	14 in./35 cm
Hose Whips	Included
Port Size	-8 SAE O-ring

ACCESSORIES

Drill Steels for use with Air

7/8 in./22 mm Hex × 4-1/4 in./108 mm H Thread, 24 in./61 cm UC.....	05174
---	-------

Carbide Rock Bits for use with Air

1-3/8 in./34.9 mm Diameter H Thread	05177
1-1/2 in./38.1 mm Diameter H Thread	05178
2 in./50.8 mm Diameter H Thread	04914

UC denotes dimension measured from bottom tip of tool to bottom surface of collar.

Test Equipment

Accumulator Charge Assembly (includes. Liquid Filled Gauge w/ Valve, Hose, & Charge Fitting).....	15304
Accumulator Tester.....	02835
Flow and Pressure Tester.....	04182
Accumulator Charge Kit (Includes Tester, Accumulator Charge Assembly and Charge Kit Box).....	31254

SK47 PARTS ILLUSTRATION

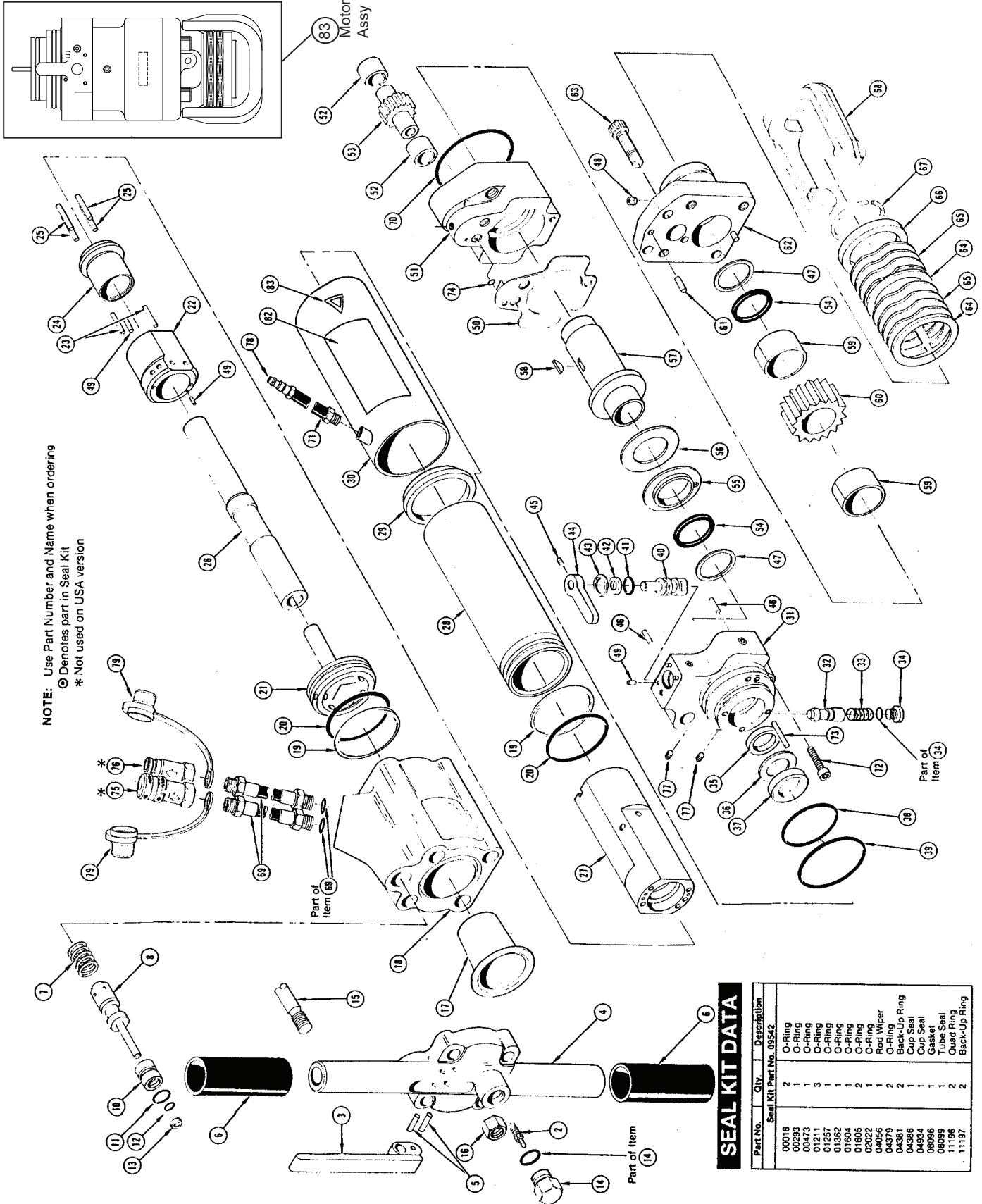

NOTE: Use Part Number and Name when ordering
 Ⓞ Denotes part in Seal Kit
 * Not used on USA version

Part No.	Qty.	Description
Seal Kit Part No. 09542		
00018	2	O-Ring
00293	1	O-Ring
00473	1	O-Ring
01211	3	O-Ring
01257	1	O-Ring
01362	1	O-Ring
01604	1	O-Ring
01605	2	O-Ring
02022	1	O-Ring
04056	1	Rod Wiper
04379	1	O-Ring
04385	2	Back-Up Ring
04934	1	Chip Seal
04936	1	Chip Seal
08096	1	Gasket
08099	1	Tube Seal
11196	1	Quad Ring
11197	2	Back-Up Ring

SK47 PARTS LIST

ITEM	PART NO.	QTY	DESCRIPTION
1	07975	1	HANDLE ASSEMBLY (INCLUDES ITEMS 2-5)
2	20499	1	CHARGE VALVE
3	04371	1	TRIGGER
4	07483	1	HANDLE
5	07492	2	SPIROL PIN
6	02494	2	HANDLE GRIP
7	04058	1	SPRING
8	04077	1	VALVE SPOOL – OPEN CENTER – MODEL SK47130
	15188	1	VALVE SPOOL – OPEN, CONSTANTON – MODEL SK47131
9	07699	1	BUSHING ASSEMBLY (INCLUDES ITEMS 10-12)
10	04057	1	BUSHING
11	00293	1	O-RING
12	01362	1	O-RING
13	04056	1	ROD WIPER
14	07493	1	CHARGE VALVE CAP
15	08087	4	SIDE ROD
16	04374	4	LOCK NUT
17	07479	1	ACCUMULATOR DIAPHRAGM
18	11588	1	ACCUMULATOR VALVE BLOCK
19	04381	2	BACK-UP RING
20	04379	2	O-RING
21	08088	1	PORTING BLOCK
22	08089	1	AUTOMATIC VALVE BODY
23	04571	2	PUSH PIN
24	04382	1	AUTOMATIC VALVE
25	04605	4	PUSH PIN
26	08091	1	PISTON
27	08090	1	FLOW SLEEVE
28	04383	1	FLOW SLEEVE TUBE
29	08099	1	TUBE SEAL
30	08100	1	AIR TUBE ASSEMBLY
31	31992	1	DRIVE MOTOR CONTROL BLOCK ASSEMBLY
	16446	1	DRIVE MOTOR CONTROL BLOCK ASSEMBLY W/O DELAY VALVE
32	08097	1	VALVE SPOOL
33	08098	1	SPRING
34	08104	1	O-RING PLUG
35	04934	1	CUP SEAL
36	04780	1	WASHER
37	04386	1	CUP SEAL
38	02022	1	O-RING
39	00473	1	O-RING

ITEM	PART NO.	QTY	DESCRIPTION
40	04937	1	MOTOR CONTROL VALVE
41	01211	3	O-RING
42	04938	1	WASHER
43	04940	1	RETAINING RING
44	04939	1	LEVER
45	01607	1	SETSCREW
46	01749	2	ROLL PIN
47	11197	2	BACK-UP RING
48	00783	1	PIPE PLUG
49	02900	5	ROLL PIN
50	08096	1	GASKET
51	08095	1	MOTOR CHAMBER
52	03826	2	BEARING
53	04033	1	IDLE GEAR
54	11196	2	QUAD RING
55	04949	1	THRUST BACK-UP WASHER
56	04948	1	THRUST WASHER
57	08094	1	DRIVE HEX
58	04787	1	KEY
59	04947	2	BEARING
60	05975	1	DRIVE GEAR
61	00713	2	DOWEL PIN
62	08093	1	MOTOR PLATE
63	00682	2	CAPSCREW
64	04756	2	LATCH WASHER
65	07063	8	WAVE SPRING
66	04759	1	BACK-UP SPRING
67	04761	1	RETAINING RING
68	16445	1	LATCH
69	01652	2	HOSE ASSY
70	01257	1	O-RING
71	04801	1	HOSE ASSY
72	00769	1	CAPSCREW
73	00114	1	ROLL PIN
74	00018	2	O-RING
75	03972	1	FEMALE COUPLER
76	03973	1	MALE COUPLER
77	18643	4	SETSCREW
82	08103	1	NAME TAG
83	30645	1	MOTOR ASSEMBLY
SK1	09542	1	SEAL KIT (INCLUDES ITEMS 11-13, 19, 20, 29, 35, 37-39, 41, 47, 50, 54, 70 & 74)

STANLEY®

STANLEY Infrastructure
6430 SE Lake Road
Portland, Oregon 97222 USA
(503) 659-5660 / Fax (503) 652-1780
www.stanleyinfrastructure.com